

# WHO CLEANS OUR WATER?

Wendell the Duck Visits  
the Wastewater Treatment Plant





Hi, kids, I'm Wendell  
the Duck. I'm here  
to teach you about  
wastewater!

We need clean water for lots of things:



**DRINKING**



**TAKING  
SHOWERS**



**COOKING**

**BRUSHING  
TEETH**

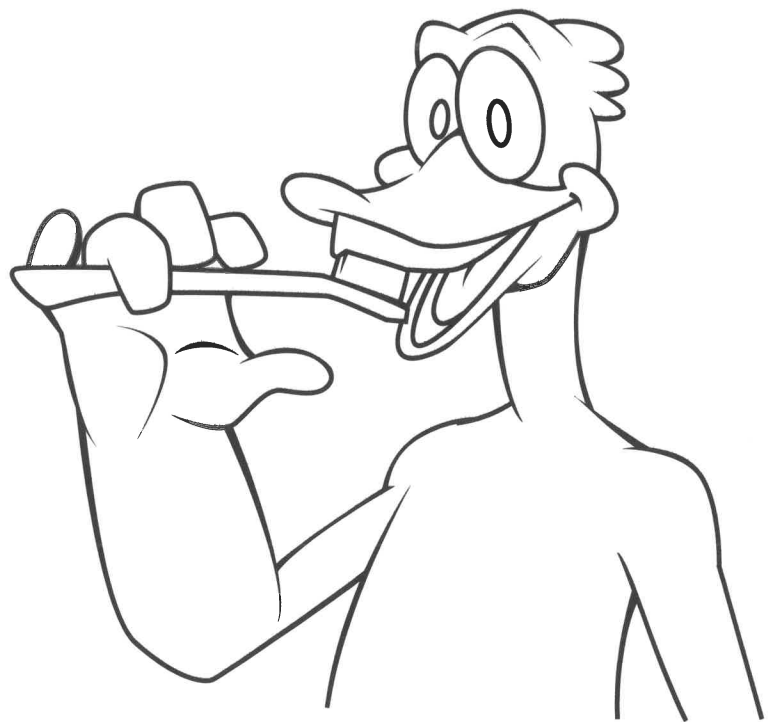

When we use water, it gets dirty.  
Dirty water is called wastewater.

Wastewater has to be cleaned before we can use it again.



Wastewater flows through pipes under the ground. The pipes carry the water to the wastewater treatment plant.

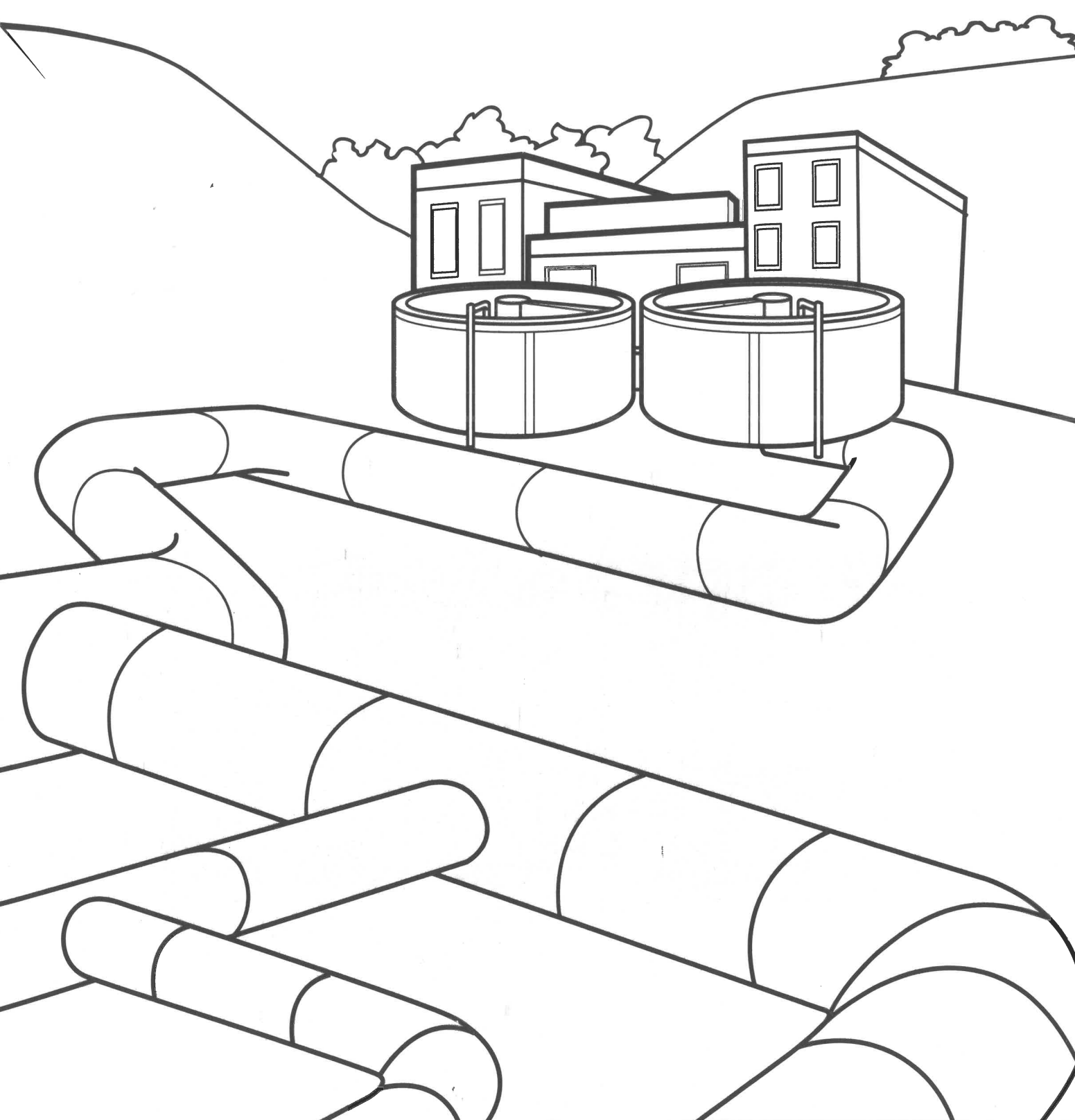

Let's go to the wastewater treatment plant!



The wastewater treatment plant cleans the water so our cities will stay clean and healthy.

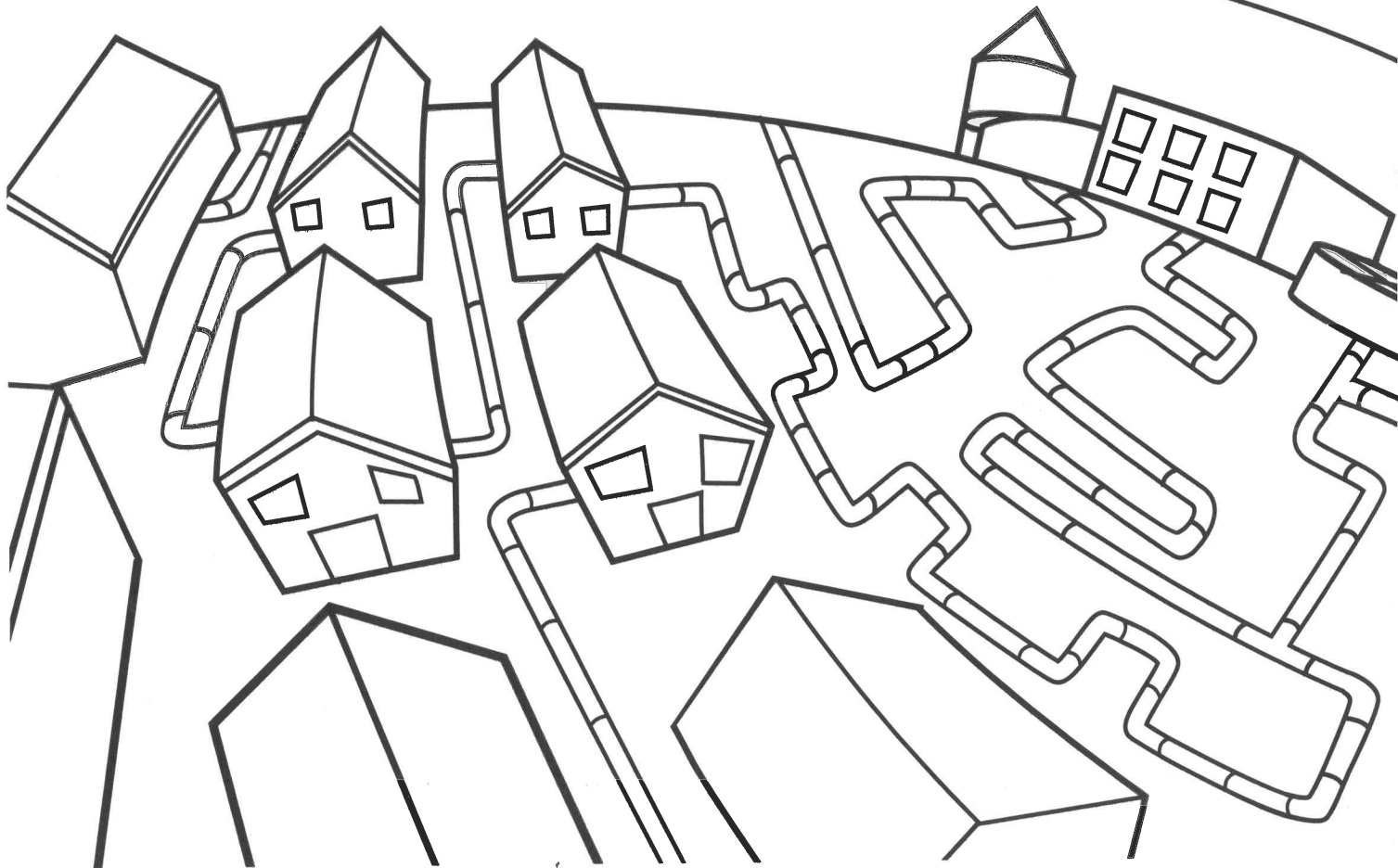

Help the water droplet get to the  
wastewater treatment plant.

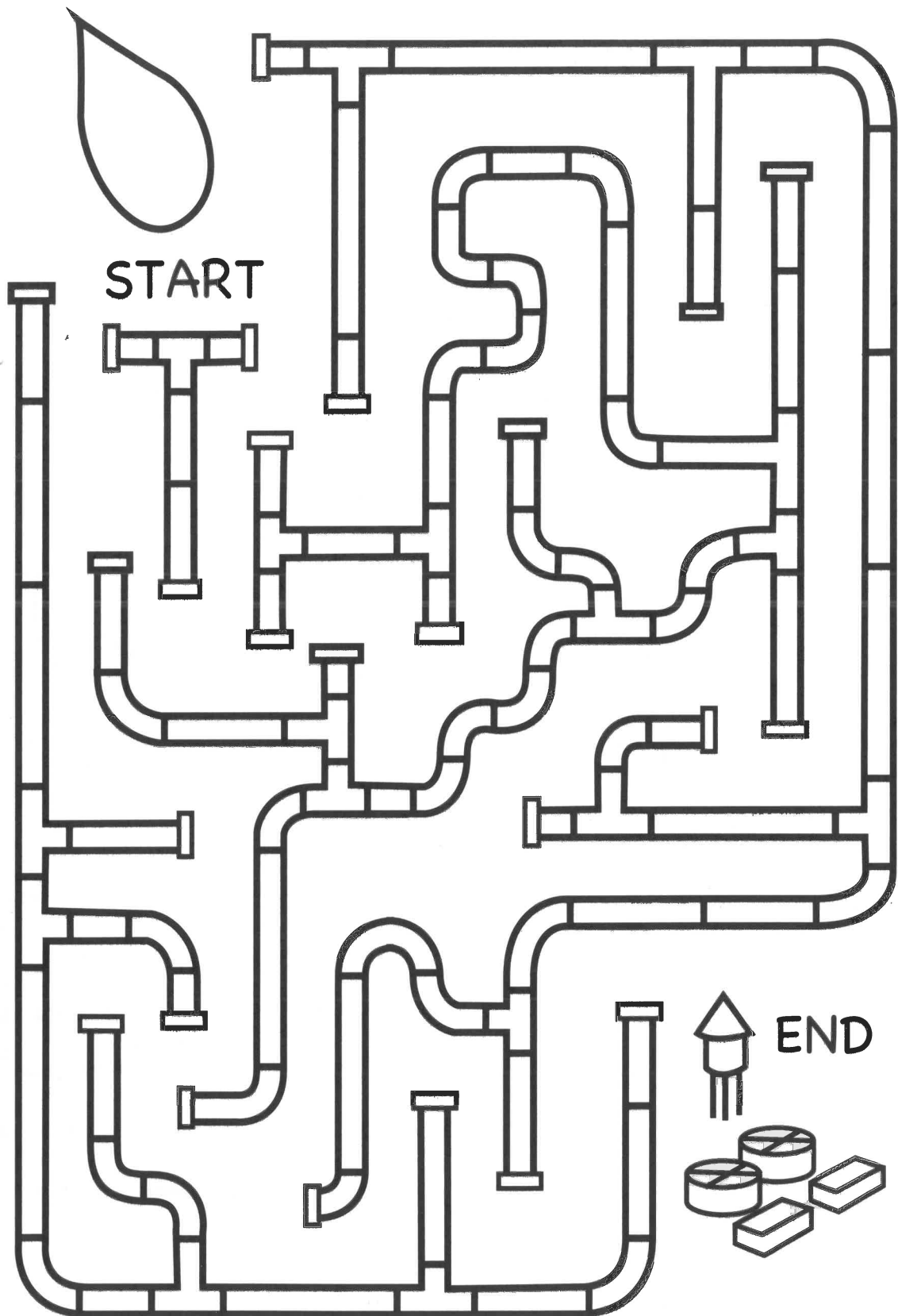



There are lots of people at the wastewater treatment plant who make sure the water gets clean.

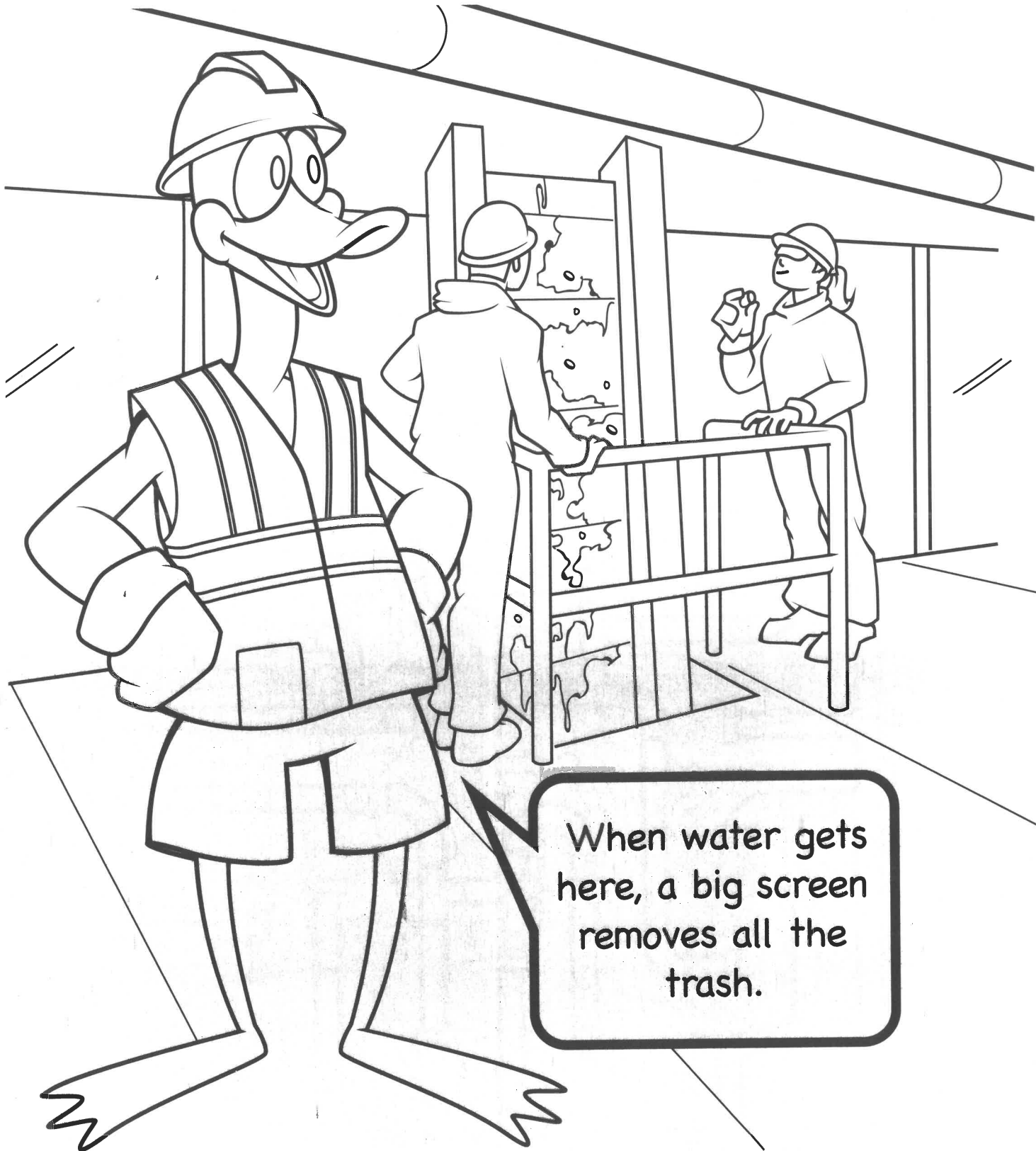

When water gets here, a big screen removes all the trash.



Then the water goes into a big tank. Icky stuff floats to the top, and workers scoop it out. Heavier gunk, called sludge, sinks to the bottom. The sludge is treated and sanitized, which turns it into biosolids.

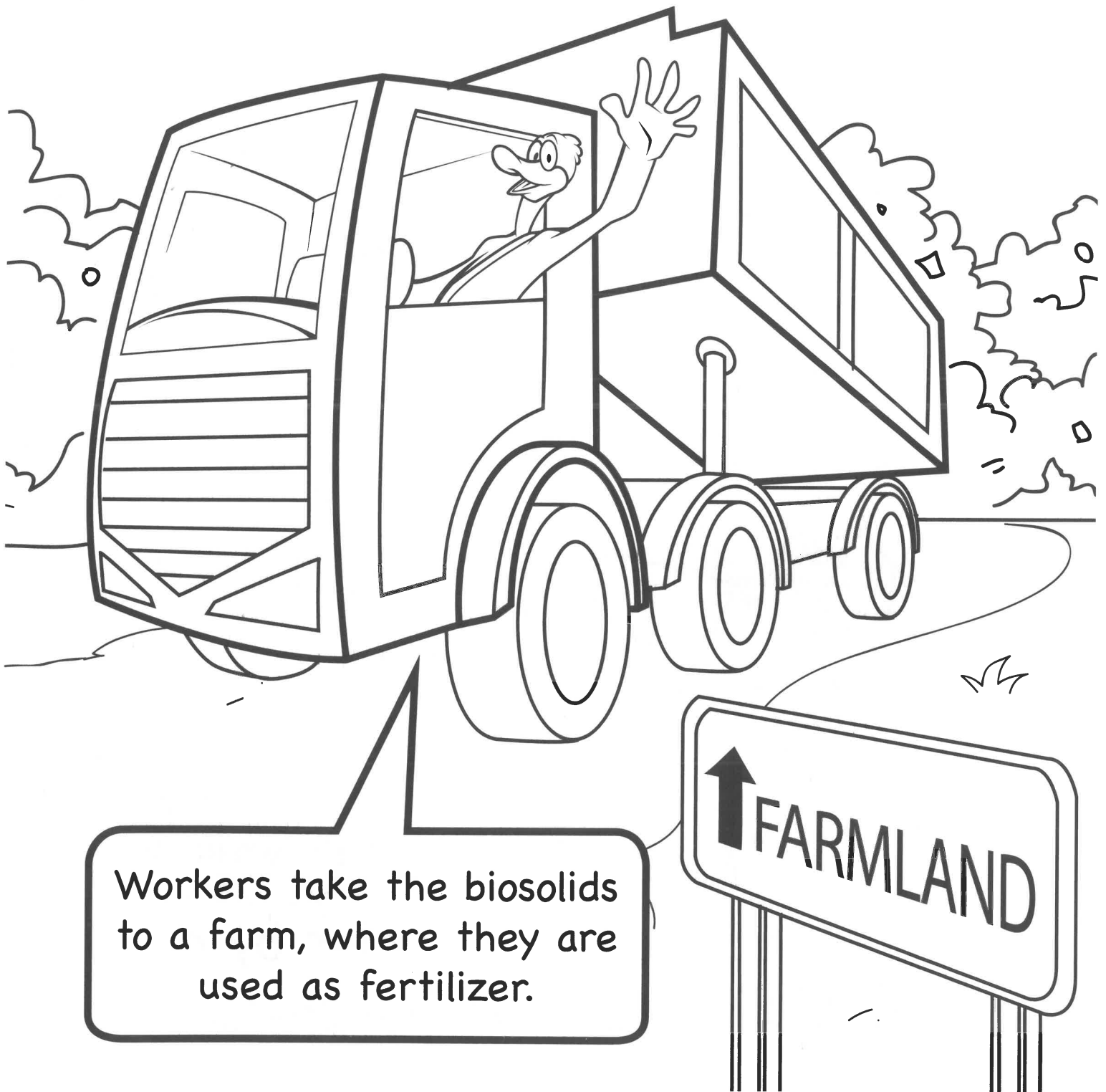

At the wastewater treatment plant, workers add air to the water. Air helps bacteria grow. Bacteria are tiny living things you can see only with a microscope.

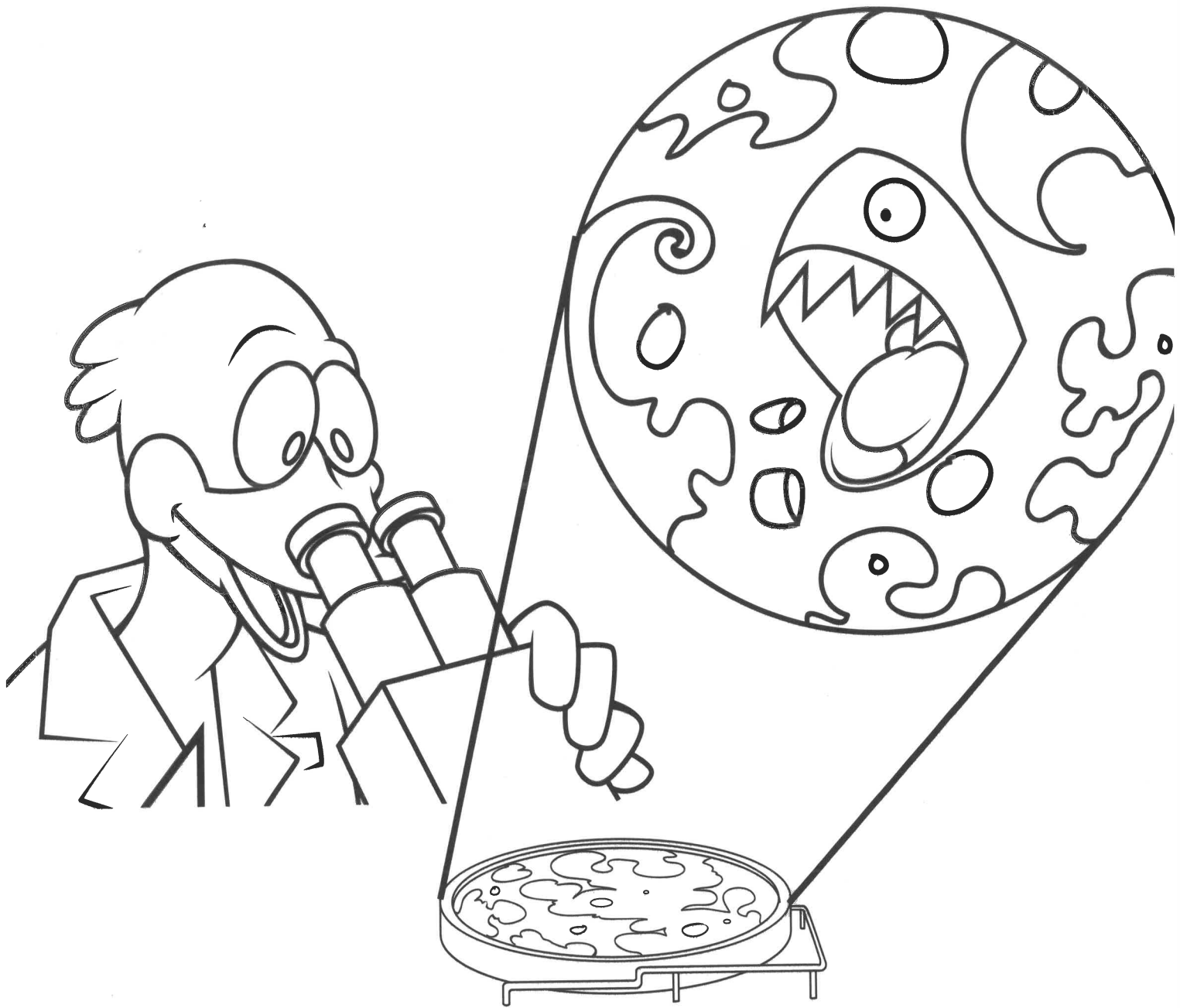

Bacteria help clean the water by eating other tiny things in the sewage.

Now the water is clean, so it can go back into oceans, underground aquifers, and other local waterways.

It's safe for the plants and animals that live in water.

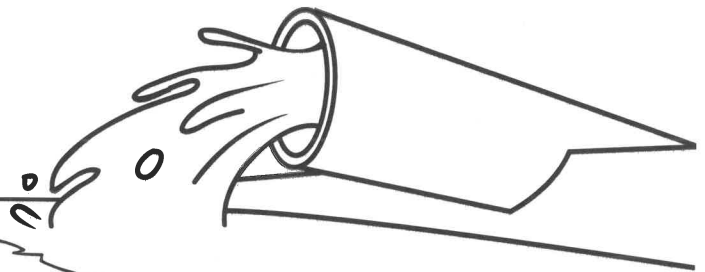

Connect the dots to see an animal that lives in clean water.



Wastewater treatment plants do a lot of work, but they still need our help!

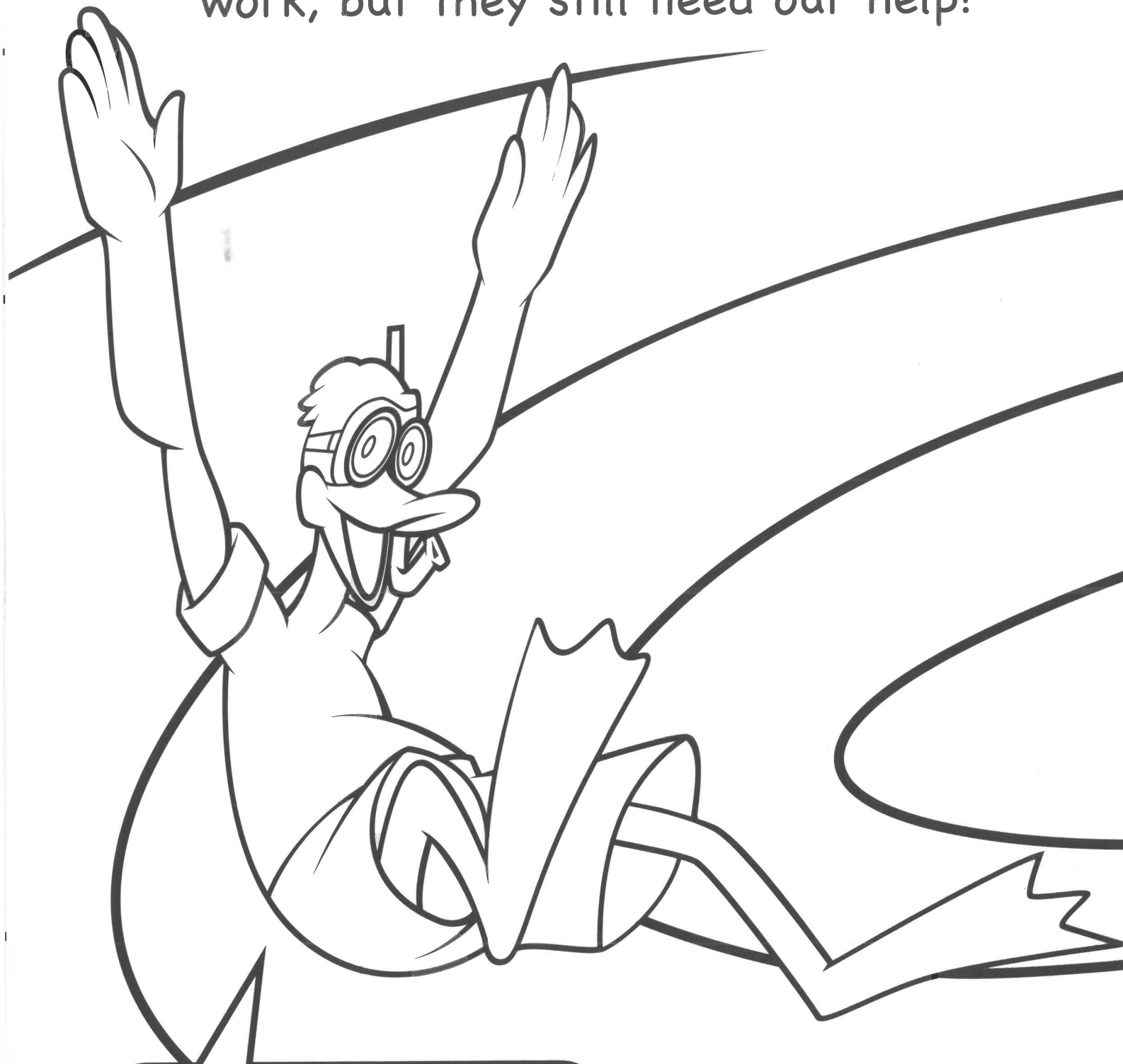

You can do a lot to keep our water clean.

Don't flush or pour these things down the drain:

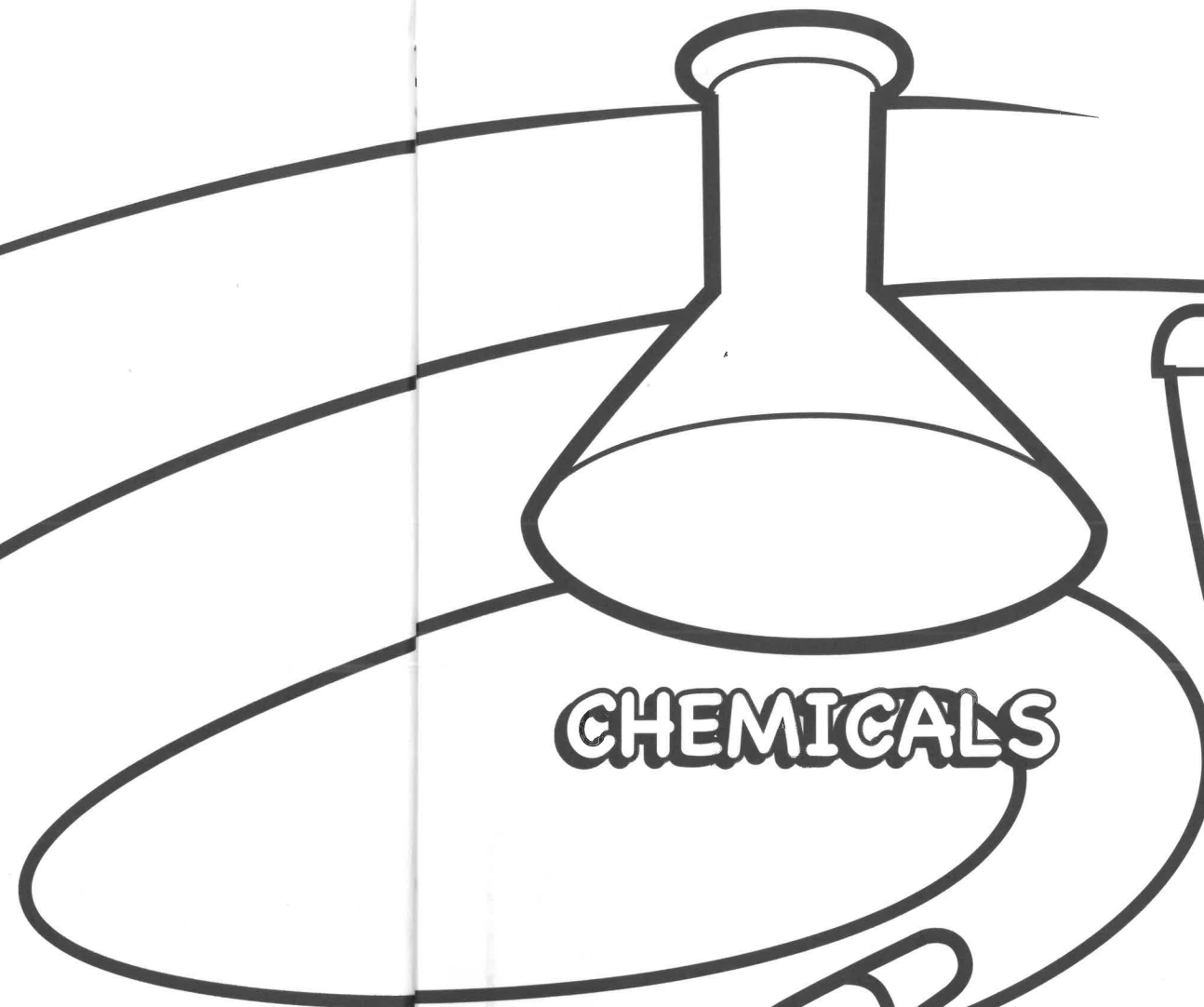

Fats, oils, and greases are called FOGs. They cause smelly clogs. Look for these FOGs in your kitchen:

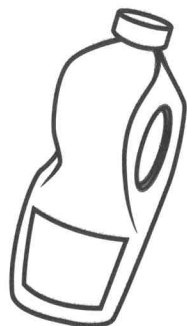

COOKING OIL

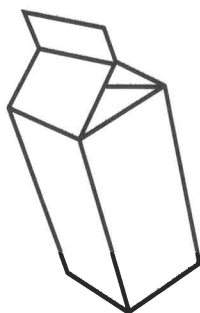

MILK AND CREAM



MAYONNAISE



SALAD DRESSING



GRAVY



PEANUT BUTTER

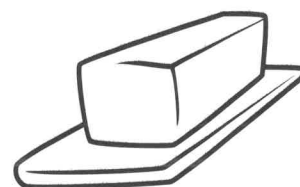

BUTTER



Don't pour FOGs down the drain!  
Pour them into an old can or  
carton, then throw it away.

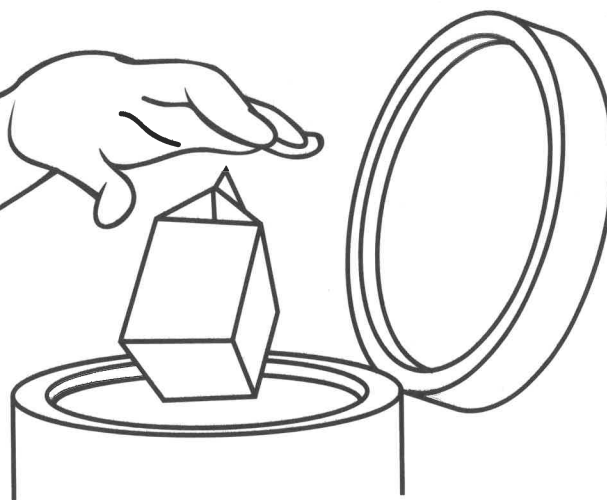

You can also help out by saving water. When you save water, there's less water to clean!



Turn off the faucet when you brush your teeth.



Time how long it takes to shower, and then try to beat your record!

A black and white line drawing of a man in a life preserver talking to a fish. The man is wearing a life preserver with a small 'R' on it and has a speech bubble above him. A fish is swimming nearby with a speech bubble above it. The background shows a simple landscape with mountains and a body of water.

Clean water  
is good for  
everybody!

And every  
animal!





This book is published by The Education & Outreach Company. For information about The Education & Outreach Company, go to [www.educationandoutreach.com](http://www.educationandoutreach.com).

Notice: This booklet was produced by The Education & Outreach Company. Neither The Education & Outreach Company nor any person acting on behalf of The Education & Outreach Company makes any warranty, express or implied, with respect to the use of any information disclosed in this booklet, or assumes any liability with respect to the use of, or for damages resulting from the use of, any information contained in this booklet.

©2023 The Education & Outreach Company. All rights reserved.

ES430-01